

**PRICE LIST**  
**LISTINO PREZZI**

2011



**GIULIO BARBIERI**  
Special Modular Coverings





**NEW GENERATION TENTS**  
GAZEBO DI NUOVA GENERAZIONE



## Leader

4

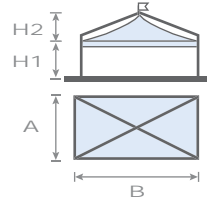
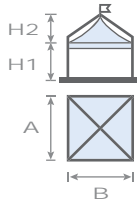

A=B (cm)	H1 (cm)	€	H2 (cm)	AREA (sqm) (mq)	A (cm)	B (cm)	H1 (cm)	€	H2 (cm)	AREA (sqm) (mq)
300	250	<b>2292,00</b>	150	9,0	300	400	250	<b>2591,00</b>	170	12,0
	300	2345,00					300	2645,00		
400	250	<b>2621,00</b>	190	16,0	300	500	250	<b>2795,00</b>	195	15,0
	300	2674,00					300	2848,00		
500	250	<b>3073,00</b>	230	25,0	300	600	250	<b>3381,00</b>	220	18,0
	300	3126,00					300	3434,00		
600	250	<b>4014,00</b>	270	36,0	400	500	250	<b>3042,00</b>	210	20,0
	300	4068,00					300	3095,00		
					400	600	250	<b>3587,00</b>	235	24,0
							300	3641,00		
					500	600	250	<b>3918,00</b>	250	30,0
							300	3971,00		

## Leader

6

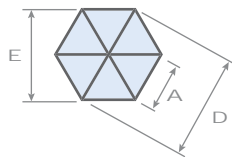
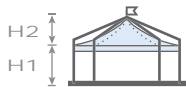

A (cm)	H1 (cm)	€	H2 (cm)	AREA (sqm) (mq)	D (cm)	E (cm)
300	250	<b>4350,00</b>	200	23,4	600	520
	300	4437,00				
400	250	<b>4933,00</b>	255	41,5	800	690
	300	5018,00				
500	250	<b>6519,00</b>	305	65,0	1000	865
	300	6606,00				

## Leader

8

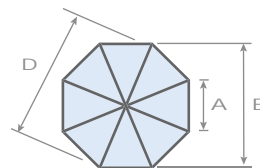

A (cm)	H1 (cm)	€	H2 (cm)	AREA (sqm) (mq)	D (cm)	E (cm)
300	250	<b>6081,00</b>	250	43,5	785	725
	300	6197,00				
400	250	<b>7657,00</b>	330	77,5	1045	965
	300	7773,00				

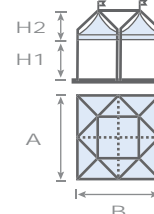
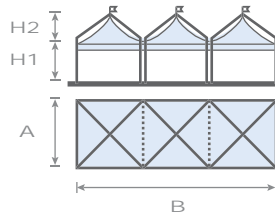
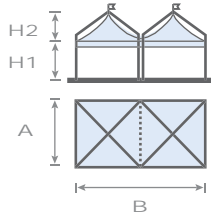

A (cm)	B (cm)	H1 (cm)	€	H2 (cm)	AREA (sqm) (mq)	A (cm)	B (cm)	H1 (cm)	€	H2 (cm)	AREA (sqm) (mq)	A=B (cm)	H1 (cm)	€	H2 (cm)	AREA (sqm) (mq)
300	600	250	4515,00	150	18,0	300	900	250	6736,00	150	27,0	700	250	7348,00	170	49,0
		300	4621,00					300	6896,00				300	7508,00		
400	800	250	5101,00	190	32,0	400	1200	250	7582,00	190	48,0					
		300	5208,00					300	7742,00							
500	1000	250	5943,00	230	50,0	500	1500	250	8815,00	230	75,0					
		300	6050,00					300	8975,00							
600	1200	250	7740,00	270	72,0	600	1800	250	11465,00	270	108,0					
		300	7846,00					300	11625,00							

 OPTIONS FOR DYNAMIC MODEL  
 OPTIONS MODELLO DYNAMIC

 FRAME COLOURS  
 COLORI DELLA STRUTTURA

 STANDARD  Ral 9010

- OPTIONAL+7%**
- Ral 9005
  - Ral 1023
  - Ral 6005
  - Ral 5010
  - Ral 3002

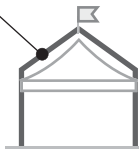
 TOP COVER AND VALANCES  
 TELA DI COPERTURA E MANTOVANE

STANDARD

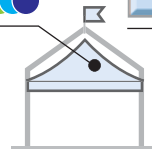
**OPTIONAL+3%**
**OPTIONAL +3%**  
**BLACK-OUT**  
**OSCURANTE**

STANDARD

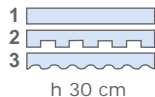
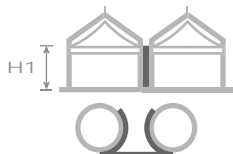
 JUNCTION FILLER  
 COPRIFESSURA

H1 (cm)	€
250	30,00
300	36,00

 KIT FOR MODULES CONNECTION  
 KIT UNIONE MODULI



SIDE LATO (cm)	€	SIDE LATO (cm)	€
300	102,00	600	141,00
400	114,00	700	259,00
500	127,00		

 CENTRAL JOINT  
 GIUNTO CENTRALE

MODEL MODELLO	€ each cad.	MODEL MODELLO	€ each cad.
LEADER 4	206,00	LEADER 8	206,00
LEADER 6	206,00	LEADER MULTI	37,00

## Dynamic

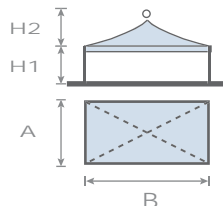
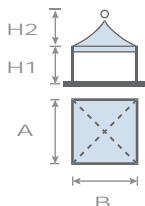
4



A=B (cm)	H1 (cm)	€	H2 (cm)	AREA (sqm) (mq)	A (cm)	B (cm)	H1 (cm)	€	H2 (cm)	AREA (sqm) (mq)
300	250	<b>2350,00</b>	130	9,0	300	400	250	<b>2642,00</b>	150	12,0
	300	2403,00					300	2695,00		
400	250	<b>2687,00</b>	170	16,0	300	500	250	<b>2859,00</b>	175	15,0
	300	2739,00					300	2913,00		
500	250	<b>3116,00</b>	210	25,0	300	600	250	<b>3425,00</b>	200	18,0
	300	3169,00					300	3478,00		
600	250	<b>4100,00</b>	250	36,0	400	500	250	<b>3093,00</b>	190	20,0
	300	4154,00					300	3146,00		
					400	600	250	<b>3673,00</b>	215	24,0
							300	3726,00		
					500	600	250	<b>3946,00</b>	230	30,0
							300	4000,00		

## Dynamic

6

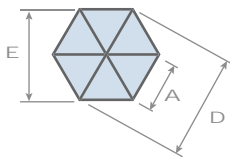

A (cm)	H1 (cm)	€	H2 (cm)	AREA (sqm) (mq)	D (cm)	E (cm)
300	250	<b>4388,00</b>	180	23,4	600	520
	300	4475,00				
400	250	<b>4935,00</b>	235	41,5	800	690
	300	5022,00				
500	250	<b>6678,00</b>	285	65,0	1000	865
	300	6765,00				

## Dynamic

8

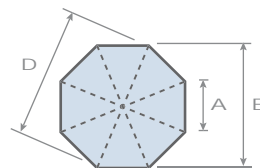

A (cm)	H1 (cm)	€	H2 (cm)	AREA (sqm) (mq)	D (cm)	E (cm)
300	250	<b>6055,00</b>	250	43,5	785	725
	300	6170,00				
400	250	<b>7795,00</b>	330	77,5	1045	965
	300	7911,00				

## Dynamic

MULTI

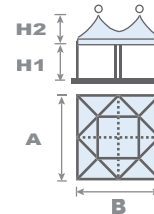
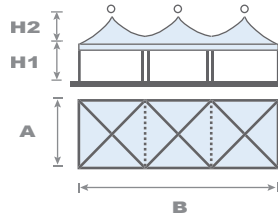
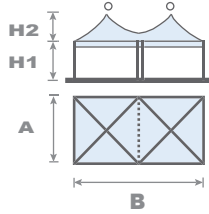

A (cm)	B (cm)	H1 (cm)	€	H2 (cm)	AREA (sqm) (mq)	A (cm)	B (cm)	H1 (cm)	€	H2 (cm)	AREA (sqm) (mq)	A=B (cm)	H1 (cm)	€	H2 (cm)	AREA (sqm) (mq)
300	600	250	4451,00	130	18,0	300	900	250	6552,00	130	27,0	700	250	7218,00	150	49,0
		300	4558,00					300	6713,00				300	7377,00		
400	800	250	5054,00	170	32,0	400	1200	250	7421,00	170	48,0					
		300	5161,00					300	7582,00							
500	1000	250	5851,00	210	50,0	500	1500	250	8588,00	210	75,0					
		300	5959,00					300	8748,00							
600	1200	250	7732,00	250	72,0	600	1800	250	11365,00	250	108,0					
		300	7839,00					300	11525,00							

### OPTIONALS FOR DYNAMIC MODEL OPTIONALS MODELLO DYNAMIC

#### FRAME COLOURS COLORI DELLA STRUTTURA

STANDARD Ral 9010

- OPTIONAL+7%**
- Ral 9005
  - Ral 1023
  - Ral 6005
  - Ral 5010
  - Ral 3002

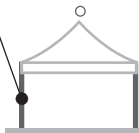

#### TOP COVER AND VALANCES TELO DI COPERTURA E MANTOVANE

STANDARD

**OPTIONAL +3%**  
BLACK-OUT  
OSCURANTE

**OPTIONAL+3%**

STANDARD

- 1
- 2
- 3

h 30 cm

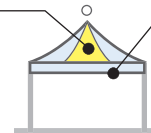
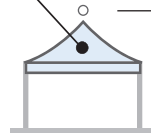

#### JUNCTION FILLER COPRIFESSURA

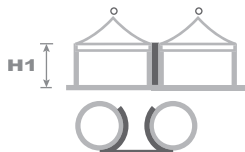

H1 (cm)	€
250	30,00
300	36,00

#### KIT FOR MODULES CONNECTION KIT UNIONE MODULI



SIDE LATO (cm)	€	SIDE LATO (cm)	€
300	102,00	600	141,00
400	114,00	700	259,00
500	127,00		

#### CENTRAL JOINT GIUNTO CENTRALE



MODEL MODELLO	€ each cad.	MODEL MODELLO	€ each cad.
LEADER 4	206,00	LEADER 8	206,00
LEADER 6	206,00	LEADER MULTI	37,00

A=B (cm)	H1 (cm)	€	H2 (cm)	AREA (sqm) (mq)	A=B (cm)	H1 (cm)	€	H2 (cm)	AREA (sqm) (mq)		
800	250	<b>12567,00</b>	185	64,0	1000	250	<b>15635,00</b>	226	100,0		
	300	12694,00				300	15918,00				
					1200	250	<b>19706,00</b>	270	144,0		
					300	19987,00					
					1300	250	<b>22377,00</b>	288	169,0		
					300	22658,00					
A (cm)	B (cm)	H1 (cm)	€	H2 (cm)	AREA (sqm) (mq)	A (cm)	B (cm)	H1 (cm)	€	H2 (cm)	AREA (sqm) (mq)
400	800	250	<b>8356,00</b>	185	32,0	500	1000	250	<b>9833,00</b>	226	50,0
		300	8481,00					300	10036,00		
						600	1200	250	<b>11175,00</b>	270	72,0
						300	11379,00				

OPTIONALS FOR ELITE MODEL  
OPTIONALS MODELLO ELITE

**FRAME COLOURS**  
COLORI DELLA STRUTTURA

STANDARD  Ral 9010

**OPTIONAL + 7%**

Ral 9005   
  Ral 1023  
 Ral 6005   
  Ral 5010  
 Ral 3002

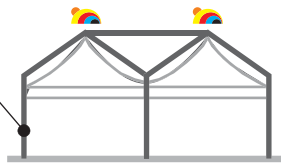

**TOP COVER AND VALANCES**  
TELO DI COPERTURA E MANTOVANE

STANDARD 

**OPTIONAL + 3%**  
**BLACK-OUT**  
OSCURANTE

**OPTIONAL + 3%**

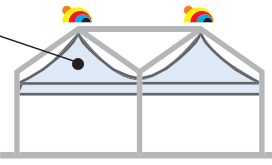
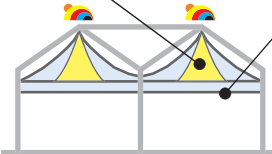
STANDARD

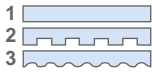

1  
2  
3

h 30 cm

**JUNCTION FILLER**  
COPRIFESSURA



H1



H1 (cm)	€
250	53,00
300	64,00

**KIT FOR MODULES CONNECTION**  
KIT UNIONE MODULI

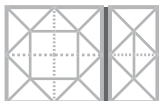

SIDE LATO (cm)	€	SIDE LATO (cm)	€
400	114,00	1000	284,00
500	127,00	1200	312,00
600	141,00	1300	322,00
800	259,00		

**CENTRAL JOINT**  
GIUNTO CENTRALE

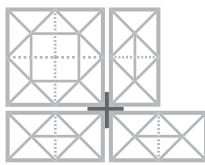

€

206,00

A=B (cm)	H1 (cm)	€	H2 (cm)	AREA (sqm) (mq)	A=B (cm)	H1 (cm)	€	H2 (cm)	AREA (sqm) (mq)		
800	250	<b>13762,00</b>	165	64,0	1000	250	<b>16798,00</b>	206	100,0		
	300	13887,00				300	17080,00				
					1200	250	<b>21273,00</b>	250	144,0		
						300	21556,00				
					1300	250	<b>23722,00</b>	268	169,0		
						300	24004,00				
A (cm)	B (cm)	H1 (cm)	€	H2 (cm)	AREA (sqm) (mq)	A (cm)	B (cm)	H1 (cm)	€	H2 (cm)	AREA (sqm) (mq)
400	800	250	<b>8084,00</b>	165	32,0	500	1000	250	<b>9529,00</b>	206	50,0
		300	8209,00					300	9733,00		
						600	1200	250	<b>10943,00</b>	250	72,0
								300	11148,00		

OPTIONALS FOR ELITE-IN MODEL  
 OPTIONALS MODELLO ELITE-IN

**FRAME COLOURS**  
COLORI DELLA STRUTTURA

STANDARD Ral 9010

**OPTIONAL +7%**

- Ral 9005
- Ral 1023
- Ral 6005
- Ral 5010
- Ral 3002

**TOP COVER AND VALANCES**  
TELO DI COPERTURA E MANTOVANE

STANDARD

**OPTIONAL +3%**  
**BLACK-OUT**  
OSCURANTE

**OPTIONAL +3%**

STANDARD

h 30 cm

**JUNCTION FILLER**  
COPRIFESSURA

H1

H1 (cm)	€
250	53,00
300	64,00

**KIT FOR MODULES CONNECTION**  
KIT UNIONE MODULI

SIDE LATO (cm)	€	SIDE LATO (cm)	€
400	114,00	1000	284,00
500	127,00	1200	312,00
600	141,00	1300	322,00
800	259,00		

**CENTRAL JOINT**  
GIUNTO CENTRALE

€

206,00

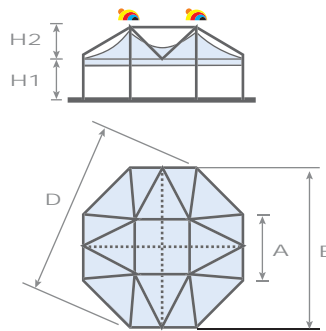

A (cm)	H1 (cm)	€	H2 (cm)	AREA (sqm) (mq)	D (cm)	E (cm)
500	250	<b>24837,00</b>	280	120,0	1305	1205
	300	25079,00				
600	250	<b>27348,00</b>	330	174,0	1570	1450
	300	27590,00				

OPTIONS FOR MEETING MODEL  
 OPTIONS MODELLO MEETING

**FRAME COLOURS**  
COLORI DELLA STRUTTURA

STANDARD Ral 9010

**OPTIONAL + 7%**

Ral 9005    Ral 1023  
 Ral 6005    Ral 5010  
 Ral 3002

**TOP COVER AND VALANCES**  
TELO DI COPERTURA E MANTOVANE

STANDARD

**OPTIONAL + 3%**  
**BLACK-OUT**  
OSCURANTE

**OPTIONAL + 3%**

STANDARD

- 1
- 2
- 3

h 30 cm

**JUNCTION FILLER**  
COPRIFESSURA

H1

H1 (cm)	€
250	53,00
300	64,00

**KIT FOR MODULES CONNECTION**  
KIT UNIONE MODULI

SIDE LATO (cm)	€
500	127,00
600	141,00





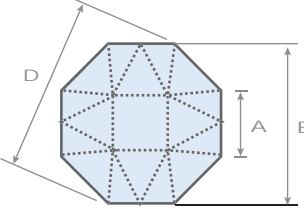







A (cm)	H1 (cm)	€	H2 (cm)	AREA (sqm) (mq)	D (cm)	E (cm)
500	250	<b>24837,00</b>	280	120,0	1305	1205
	300	25079,00				
600	250	<b>27348,00</b>	330	174,0	1570	1450
	300	27590,00				

OPTIONALS FOR MEETING MODEL  
OPTIONALS MODELLO MEETING

**FRAME COLOURS**  
COLORI DELLA STRUTTURA

STANDARD  Ral 9010

**OPTIONAL + 7%**

 Ral 9005     Ral 1023  
 Ral 6005     Ral 5010  
 Ral 3002



**TOP COVER AND VALANCES**  
TELO DI COPERTURA E MANTOVANE

STANDARD 

**OPTIONAL + 3%**  
**BLACK-OUT**  
OSCURANTE

**OPTIONAL + 3%**

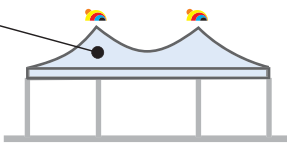
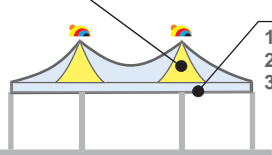



STANDARD



h 30 cm

**JUNCTION FILLER**  
COPRIFESSURA



H1



H1 (cm)	€
250	53,00
300	64,00

**KIT FOR MODULES CONNECTION**  
KIT UNIONE MODULI

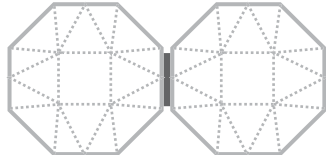

SIDE LATO (cm)	€
500	127,00
600	141,00



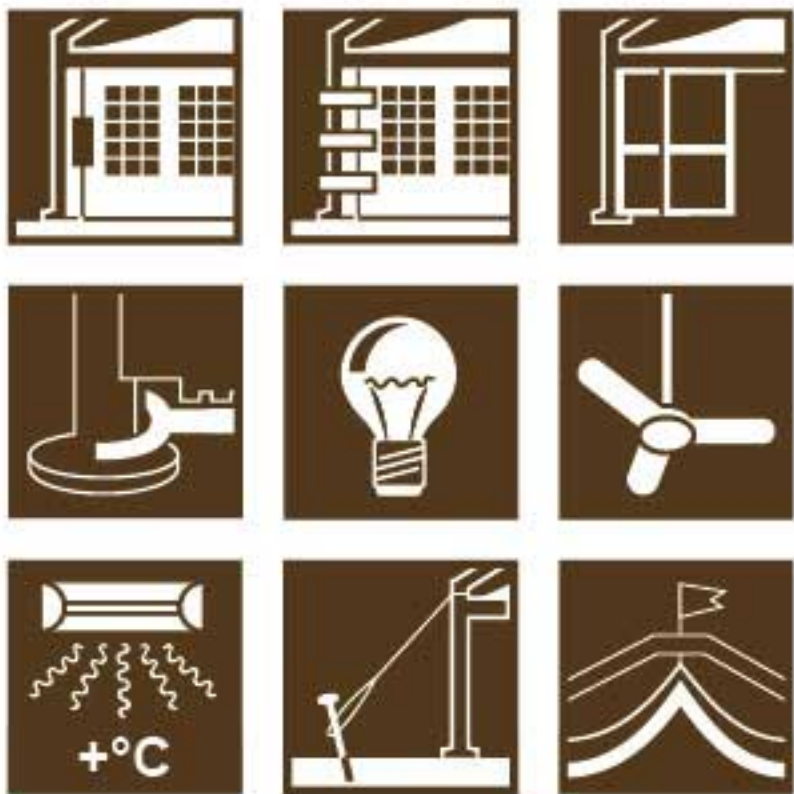

**OPTIONALS**  
**ACCESSORI**





“CLACK” MODEL: PVC SLIDING SIDE CLOSING  
 CHIUSURA SCORREVOLE MODELLO “CLACK” IN TELO PVC



“CLACK” CLOSING FOR THE NEW GENERATION TENTS  
 CHIUSURA “CLACK” PER GAZEBO DI NUOVA  
 GENERAZIONE

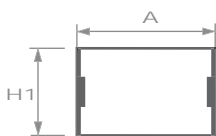

PLAIN WALL  
STANDARD

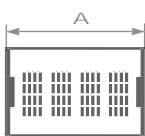

WINDOWS  
WALL  
FINESTRATA

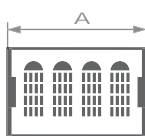

ARCHED WINDOWS  
WALL  
FINESTRATA  
AD ARCO



ALUMINIUM  
GROUND GUIDE  
GUIDA A TERRA  
IN ALLUMINIO

A (cm)	H1 (cm)	€	€	€	€
300	250	328,00	389,00	421,00	103,00
	300	374,00	445,00	481,00	
350	250	359,00	429,00	464,00	113,00
	300	412,00	492,00	532,00	
400	250	379,00	455,00	492,00	124,00
	300	437,00	522,00	565,00	
500	250	431,00	520,00	564,00	142,00
	300	498,00	600,00	651,00	
600	250	496,00	600,00	652,00	160,00
	300	573,00	693,00	754,00	
650	250	538,00	654,00	710,00	178,00
	300	623,00	757,00	824,00	

OTHER DIMENSIONS  
ALTRE DIMENSIONI

A (cm)	NOTES FOR : NOTE PER :	Leader MULTI Dynamic MULTI	A (cm)	NOTES FOR : NOTE PER :	Elite Elite IN
700	n. 2 side walls 350 cm + n. 1 junction filler n. 2 pareti da cm. 350 + n. 1 coprifessura		800	n. 2 side walls 400 cm + n. 1 middle pole n. 2 pareti da cm. 400 + n. 1 montante intermedio	
800	n. 2 side walls 400 cm + n. 1 junction filler n. 2 pareti da cm. 400 + n. 1 coprifessura				
1000	n. 2 side walls 500 cm + n. 1 junction filler n. 2 pareti da cm. 500 + n. 1 coprifessura				
1200	n. 3 side walls 400 cm + n. 2 junction filler n. 3 pareti da cm. 400 + n. 2 coprifessura		1000	n. 2 side walls 500 cm n. 2 pareti da cm. 500	
1500	n. 3 side walls 500 cm + n. 2 junction filler n. 3 pareti da cm. 500 + n. 2 coprifessura		1200	n. 2 side walls 600 cm n. 2 pareti da cm. 600	
1800	n. 3 side walls 600 cm + n. 2 junction filler n. 3 pareti da cm. 600 + n. 2 coprifessura		1300	n. 2 side walls 650 cm n. 2 pareti da cm. 650	

MIDDLE POLE FOR:  
MONTANTE  
INTERMEDIO PER:



H1 (cm)	€
250	375,00
300	410,00

OPTIONALS



"STRAPS" CLOSING FOR THE BASIC RANGE OF TENT  
 CHIUSURA "CINGHIETTA" PER GAZEBO GAMMA BASE

**SILVER**

Summer **4**

**FESTIVAL**

A (cm)	H1 (cm)	€	€	€	€						
300	250	248,00	311,00	340,00	103,00						
400	250	312,00	391,00	429,00	124,00						
	300	378,00	473,00	520,00							
500	250	365,00	456,00	502,00	142,00						
	300	440,00	549,00	605,00							
600	250	418,00	520,00	573,00	160,00						
	300	502,00	629,00	691,00							
OTHER DIMENSIONS ALTRE DIMENSIONI											
A (cm)	NOTES FOR: NOTE PER:	<p style="text-align: center;">TELESCOPIC POLE KIT FOR: KIT MONTANTE TELESCOPICO PER:</p> <p style="text-align: center;"><b>FESTIVAL</b></p> <table border="1" style="margin-left: auto; margin-right: auto;"> <thead> <tr> <th>H1 (cm)</th> <th>€</th> </tr> </thead> <tbody> <tr> <td>250</td> <td>108,00</td> </tr> <tr> <td>300</td> <td>117,00</td> </tr> </tbody> </table>				H1 (cm)	€	250	108,00	300	117,00
H1 (cm)	€										
250	108,00										
300	117,00										
800	n. 2 side walls 400 cm + n. 1 telescopic pole kit n. 2 pareti da cm. 400 + n. 1 kit montante telescopico										
1000	n. 2 side walls 500 cm n. 2 pareti da cm. 500										
1200	n. 2 side walls 600 cm n. 2 pareti da cm. 600										

OPTIONALS



# “ERMETICA” MODEL: RIGID SLIDING SIDE CLOSING

## CHIUSURA SCORREVOLE RIGIDA MODELLO “ERMETICA”

### “ERMETICA” RIGID SLIDING SIDE CLOSING

#### CHIUSURA PERIMETRALE RIGIDA “ERMETICA”

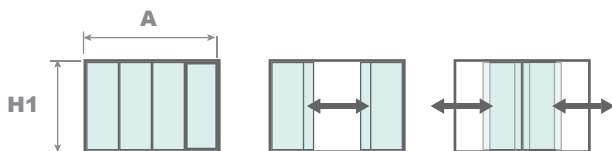

**FRAME:** made of aluminium powder coated (white colour, ral 9010).  
**SLIDING PANELS:** made of safety glass or polycarbonate 10 mm.  
**TELAIO:** in alluminio ral 9010.  
**PANNELLI:** in vetro 3+3 stratificato o polycarbonato alveolare mm.10.

A (cm)	H1 (cm)	€	A (cm)	H1 (cm)	€
300	250	2310,00	430	250	2742,00
	300	2532,00		300	3004,00
350	250	2497,00	500	250	2943,00
	300	2686,00		300	3234,00
400	250	2571,00	600	250	3142,00
	300	2813,00		300	3450,00

**FOR DIFFERENT TYPE OF PANEL: PER ALTRI TIPI DI PANNELLO:**



STANDARD  Ral 9010

**OPTIONAL+7%**

- Ral 9005
- Ral 1023
- Ral 6005
- Ral 5010
- Ral 3002

#### OTHER DIMENSIONS

#### ALTRE DIMENSIONI

A (cm)	NOTES FOR: NOTE PER:	Leader MULTI	Dynamic MULTI	A (cm)	NOTES FOR: NOTE PER:	Elite	Elite Ln	A (cm)	NOTES FOR: NOTE PER:	FESTIVAL	
700	n. 2 side walls 350 cm n. 2 pareti da cm. 350	800		800	n. 2 side walls 400 cm + n. 1 middle pole			800	n. 2 pareti da cm. 400 + n. 1 montante intermedio		n. 2 side walls 400 cm + n. 1 telescopic pole kit
800	n. 2 side walls 400 cm n. 2 pareti da cm. 400				n. 2 pareti da cm. 400 + n. 1 montante intermedio				n. 2 pareti da cm. 400 + n. 1 montante telescopico		
1000	n. 2 side walls 500 cm n. 2 pareti da cm. 500	1000		1000	n. 2 side walls 500 cm n. 2 pareti da cm. 500			1000	n. 2 side walls 500 cm n. 2 pareti da cm. 500		n. 2 side walls 500 cm n. 2 pareti da cm. 500
1200	n. 3 side walls 400 cm n. 3 pareti da cm. 400				n. 2 side walls 600 cm n. 2 pareti da cm. 600				n. 2 side walls 600 cm n. 2 pareti da cm. 600		
1500	n. 3 side walls 500 cm n. 3 pareti da cm. 500	1300		1300	n. 3 side walls 430 cm + n. 1 middle pole				n. 3 pareti da cm. 430 + n. 1 montante intermedio		n. 2 side walls 600 cm n. 2 pareti da cm. 600
1800	n. 3 side walls 600 cm n. 3 pareti da cm. 600										

**MIDDLE POLE**  
MONTANTE INTERMEDIO



**FOR: PER:**



H1 (cm)	€
250	375,00
300	410,00

**TELESCOPIC POLE KIT FOR: MONTANTE TELESCOPICO PER:**

**FESTIVAL**

H1 (cm)	€
250	108,00
300	117,00

**OPENING DOOR**  
ANTA BATTENTE



€
ON REQUEST A PREVENTIVO

OPTIONALS

"CLACK" MODEL: PVC SLIDING SIDE CLOSING  
 CHIUSURA SCORREVOLE MODELLO "CLACK" IN TELO PVC



"CLACK" CLOSING FOR BROOKLYN  
 CHIUSURA "CLACK" PER BROOKLYN

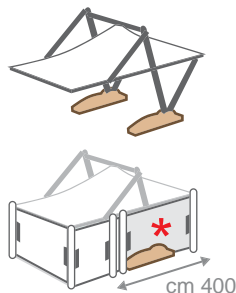

BROOKLYN WITH STANDARD ANCHORING SYSTEM (CONCRETE LOADS)  
 BROOKLYN CON ANCORAGGIO STANDARD (BASI IN CEMENTO ARMATO)

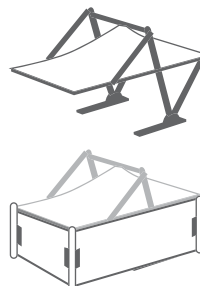

BROOKLYN WITH OPTIONAL ANCHORING SYSTEM (ANCHORING PLATES)  
 BROOKLYN CON SISTEMA DI ANCORAGGIO OPZIONALE (PIASTRE)

cm 240			
	PLAIN WALL STANDARD	WINDOWS WALL FINESTRATA	ALUMINIUM GROUND GUIDE GUIDA A TERRA IN ALLUMINIO

\* SIDE WALL PROPERLY SHAPED PARETE SAGOMATA

cm 400

Plain wall Standard

L (cm)	€	€	€
100	227,00	264,00	66,00
200	273,00	322,00	88,00
300	328,00	389,00	103,00
350	359,00	429,00	113,00
400	379,00	455,00	124,00
500	431,00	520,00	142,00
600	496,00	600,00	160,00

€ each cad.  
425,00

cm 400

Windows wall Finestrata

€ each cad.  
511,00

700	n. 2 side walls 350 cm + n. 1 curtain supporting pole n. 2 pareti da cm. 350 + n. 1 montante di sostegno		
800	n. 2 side walls 400 cm + n. 1 curtain supporting pole n. 2 pareti da cm. 400 + n. 1 montante di sostegno		

cm 240			
	PLAIN WALL STANDARD	WINDOWS WALL FINESTRATA	ALUMINIUM GROUND GUIDE GUIDA A TERRA IN ALLUMINIO

L (cm)	€	€	€
100	227,00	264,00	66,00
200	273,00	322,00	88,00
300	328,00	389,00	103,00
350	359,00	429,00	113,00
400	379,00	455,00	124,00
500	431,00	520,00	142,00
600	496,00	600,00	160,00

700	n. 2 side walls 350 cm + n. 1 curtain supporting pole n. 2 pareti da cm. 350 + n. 1 montante di sostegno		
800	n. 2 side walls 400 cm + n. 1 curtain supporting pole n. 2 pareti da cm. 400 + n. 1 montante di sostegno		

CURTAIN SUPPORTING POLE MONTANTI DI SOSTEGNO

€ each cad.  
133,00

CURTAIN SUPPORTING POLE MONTANTI DI SOSTEGNO

€ each cad.  
133,00

OPTIONALS



**LIGHTING SYSTEM**  
**SISTEMI DI ILLUMINAZIONE**

**ALUMINIUM ELECTRIC BAR**  
**ASTA ELETTTRIFICATA IN ALLUMINIO**

**HALOGEN LIGHT**  
**FARETTI ALOGENI**

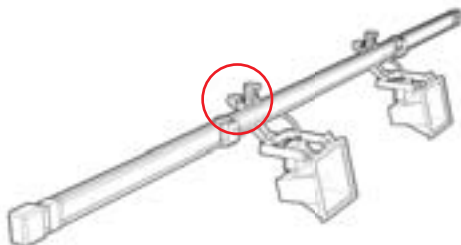

€ each  
cad.

**230,00**

**NEON LIGHT**  
**PLAFONIERA AL NEON**

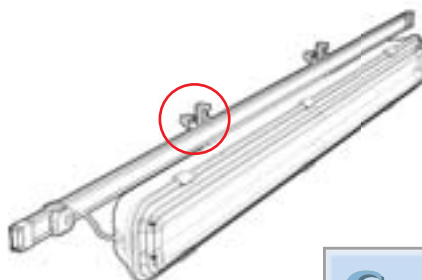

€ each  
cad.

**230,00**

**LIGHT CONTROL**  
**COMANDO LUCI**



€ each  
cad.

**239,00**

**CONNECTION**  
**CABLE**  
**CAVO DI**  
**COLLEGAMENTO**



LENGTH LUNGH. (cm)	€ each cad.	LENGTH LUNGH. (cm)	€ each cad.
400	<b>88,00</b>	1400	<b>116,00</b>
800	<b>98,00</b>	1800	<b>127,00</b>

**LOW CONSUMPTION LAMPS**  
**LAMPADIE A BASSO CONSUMO**



€ each  
cad.

**306,00**

**LIGHT CONTROL**  
**COMANDO LUCI**



€ each  
cad.

**245,00**

**CONNECTION CABLE**  
**CAVO DI COLLEGAMENTO**



LENGTH LUNGH. (cm)	€ each cad.
600	<b>87,00</b>

**OPTIONAL**  
**ADDITIONAL CABLE**  
**CAVO AGGIUNTIVO**

€ /ml **2,00**

OPTIONALS

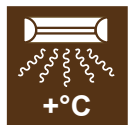

**INFRARED RAYS HEATING**  
**RISCALDATORE A RAGGI INFRAROSSI**

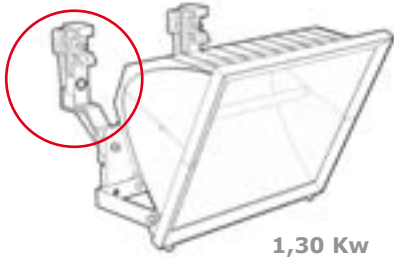

1,30 Kw

€ each  
cad.

266,00

**INFRARED RAYS HEATING**  
**RISCALDATORE A RAGGI INFRAROSSI**

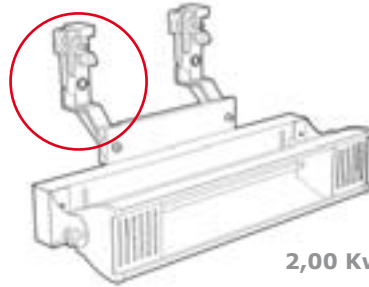

2,00 Kw

€ each  
cad.

430,00



= **SLIDE-IN TYPE FASTENING SYSTEM**  
= **SISTEMA AD AGGANCIAMENTO RAPIDO**

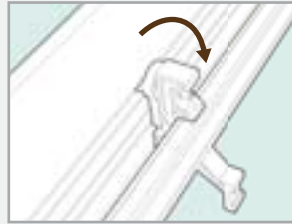

**REFRESHING SYSTEM**  
**SISTEMA DI VENTILAZIONE**



OPTIONALS

**THREE-BLADES FAN WITH CONTROL**  
**VENTILATORE A TRE PALE CON COMANDO**

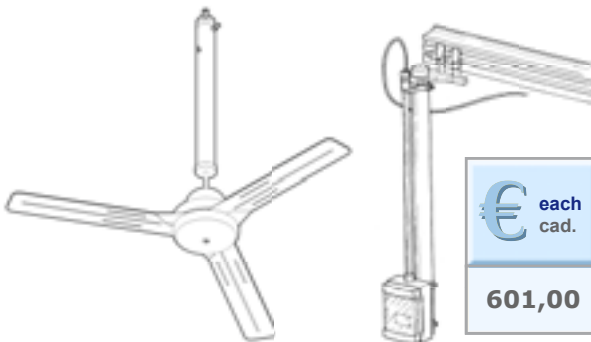

€ each  
cad.

601,00

**THREE-BLADES FAN WITH LAMP AND CONTROL**  
**VENTILATORE A TRE PALE CON LUCE E COMANDO**

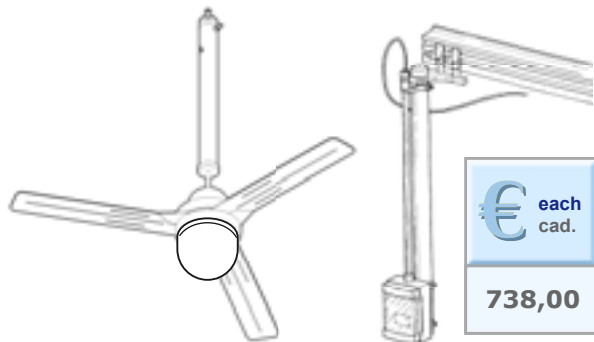

€ each  
cad.

738,00



# ANCHORING TO THE GROUND

## ANCORAGGIO AL SUOLO

### SCREW PEG - TYPE A PICCHETTO AD ELICA - TIPO A



€ each  
cad.

**16,00**

Cm. 80 long for sandy ground  
Picchetto per terreni sabbiosi  
Lungo cm. 80.

### T-SHAPED PEG - TYPE B PICCHETTO A "T" - TIPO B



€ each  
cad.

**16,00**

Cm. 80 long for hard ground  
Picchetto per terreni compatti  
lungo cm. 80.

### ROUND PEG TYPE - TYPE C PICCHETTO TONDO - TIPO C



€ each  
cad.

**16,00**

Cm. 35 long  
For asphalt  
Picchetto  
Per asfalto  
Lungo cm. 35.

### FLOWER BOX IN CONCRETE FIORIERA IN CEMENTO



€ each  
cad.

**157,00**

Weight: kg. 200  
Peso: kg. 200

### CONCRETE LOAD ZAVORRA IN CEMENTO



€ each  
cad.

**288,00**

Weight: kg. 200  
Peso: kg. 200

### SAFETY STRAP EQUIPPED WITH RATCHET CINGHIA DI SICUREZZA

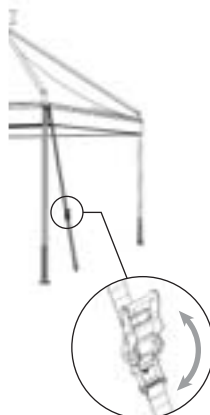

€ each  
cad.

**18,00**

With ratchet  
Completa di  
Cricchetto



**FABRIC SPECIFICATIONS**

the linings are manufactured from 100 % non-flammable polyester fibre for maximum durability and easy care. Lining Fabrics have a soft finish with a beautiful silky sheen that resist hard creasing. Standard colours: White and Champagne.

**COMPOSIZIONE:**

i controsoffitti sono realizzati in 100% fibra di poliestere non infiammabile e sono corredati di garanzia di durata. I tessuti sono inguallcibili, caratterizzati da morbida finitura con un bell'effetto seta e facile manutenzione. Colore standard: disponibile bianco e champagne.

<b>SQUARE AREA</b> <b>AREA QUADRATA</b>		
A=B (cm)	NOTES NOTE	€
300	n. 1 peak n. 1 cupola	<b>655,00</b>
400	n. 1 peak n. 1 cupola	<b>881,00</b>
500	n. 1 peak n. 1 cupola	<b>1287,00</b>
600	n. 1 peak n. 1 cupola	<b>1585,00</b>
700	n. 4 peaks n. 4 cupole	<b>2190,00</b>
800	n. 4 peaks n. 4 cupole	<b>2310,00</b>
1000	n. 4 peaks n. 4 cupole	<b>3419,00</b>
1200	n. 4 peaks n. 4 cupole	<b>4498,00</b>

<b>RECTANGULAR AREA</b> <b>AREA RETTANGOLARE</b>							
A (cm)	B (cm)	NOTES NOTE	€	A (cm)	B (cm)	NOTES NOTE	€
300	400	n. 1 peak n. 1 cupola	<b>815,00</b>	400	1200	n. 3 peaks n. 3 cupole	<b>2543,00</b>
300	500	n. 1 peak n. 1 cupola	<b>850,00</b>	500	600	n. 1 peak n. 1 cupola	<b>1375,00</b>
300	600	n. 1 peak n. 1 cupola	<b>987,00</b>	500	1000	n. 2 peaks n. 2 cupole	<b>2028,00</b>
300	600	n. 2 peaks n. 2 cupole	<b>1121,00</b>	500	1500	n. 3 peaks n. 3 cupole	<b>3746,00</b>
300	900	n. 3 peaks n. 3 cupole	<b>1892,00</b>	600	1200	n. 2 peaks n. 2 cupole	<b>2572,00</b>
400	500	n. 1 peak n. 1 cupola	<b>1054,00</b>	600	1800	n. 3 peaks n. 3 cupole	<b>4612,00</b>
400	600	n. 1 peak n. 1 cupola	<b>1301,00</b>				
400	800	n. 2 peaks n. 2 cupole	<b>1469,00</b>				

<b>HEXAGONAL AREA</b> <b>AREA ESAGONALE</b>			
A (cm)	€	A (cm)	€
300	<b>1424,00</b>	500	<b>2867,00</b>
400	<b>2057,00</b>		

<b>OCTAGONAL AREA</b> <b>AREA OTTAGONALE</b>					
A (cm)	NOTES NOTE	€	A (cm)	NOTES NOTE	€
300	n. 1 peak n. 1 cupola	<b>2130,00</b>	500	n. 4 peaks n. 4 cupole	<b>4899,00</b>
400	n. 1 peak n. 1 cupola	<b>3399,00</b>	600	n. 4 peaks n. 4 cupole	<b>6501,00</b>





**AUXILIARY OPTIONALS FOR INSTALLATION  
AND STORAGE**

**ACCESSORI AUSILIARI D'INSTALLAZIONE E  
STOCCAGGIO**

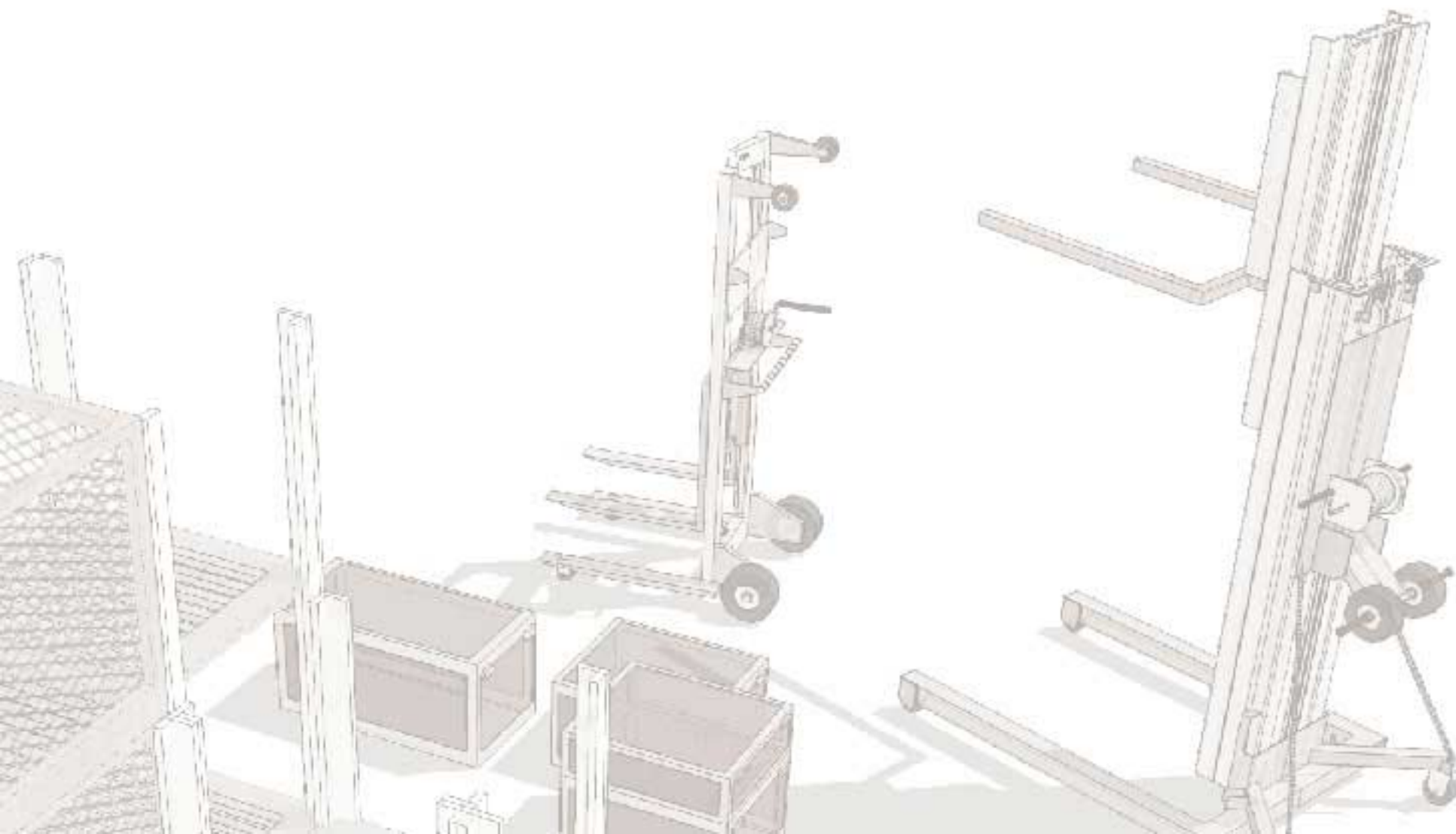



**CERTIFIED LIFTING HOISTS**  
**CARRELLI DI SOLLEVAMENTO OMOLOGATI**

MODELS MODELLI			
<b>LIFT</b>	<b>SLA 10</b>	<b>SLA 15</b>	
<p>TENT PASS HEIGHT= 250 cm ALTEZZA UTILE GAZEBO= 250 cm</p> <p><b>SILVER</b></p> <p>Summer 4</p> <p>Leader 4</p> <p>Dynamic 4</p>	<p>TENT PASS HEIGHT= 250 cm ALTEZZA UTILE GAZEBO= 250 cm</p> <p>Leader 6    Dynamic 6</p> <p>Leader 8    Dynamic 8</p> <p>Leader MULTI    Dynamic MULTI</p> <p><b>FESTIVAL</b></p> <p>Elite    Elite Ln</p>	<p>TENT PASS HEIGHT= 300 cm ALTEZZA UTILE GAZEBO= 300 cm</p> <p>Leader 6    Dynamic 6</p> <p>Leader 8    Dynamic 8</p> <p>Leader MULTI    Dynamic MULTI</p> <p><b>FESTIVAL</b>    <b>MEETING</b></p> <p>Elite    Elite Ln</p>	
	<p>H max = 300 cm</p>	<p>H max = 450 cm</p>	
	<p><b>Kg max.</b> = 159 Kg</p>	<p><b>Kg max.</b> = 454 Kg</p>	<p><b>Kg max.</b> = 363 Kg</p>
	<p>€ each cad.</p> <p><b>2682,00</b></p>	<p>€ each cad.</p> <p><b>3836,00</b></p>	<p>€ each cad.</p> <p><b>4547,00</b></p>
	<p><b>LIFTING HOIST'S WEIGHT</b> PESO DEL SOLLEVATORE</p>		
68 Kg	118 Kg	144 Kg	



**“RACK” CONTAINERS**  
**CONTENITORI “RACK”**

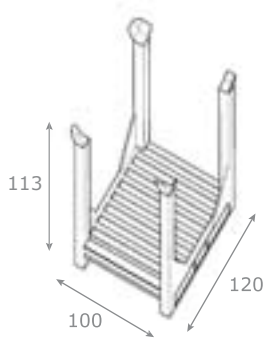

**GREY**  
**GRIGIO**  
RAL 7000

€ each  
cad.

**436,00**

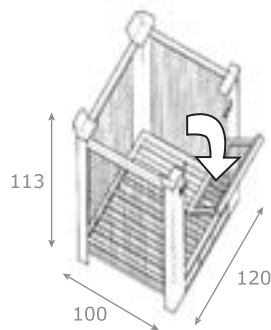

**GREY**  
**GRIGIO**  
RAL 7000

€ each  
cad.

**383,00**

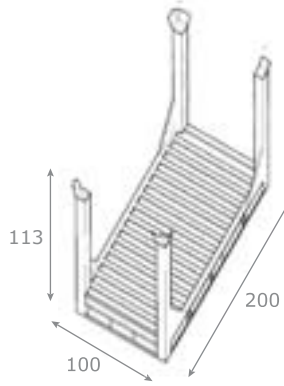

**GREY**  
**GRIGIO**  
RAL 7000

€ each  
cad.

**595,00**

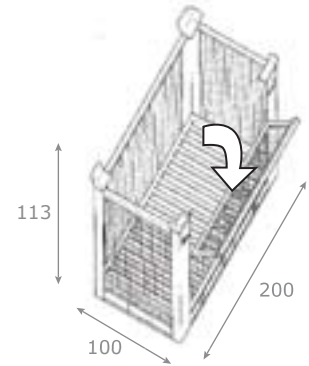

**GREY**  
**GRIGIO**  
RAL 7000

€ each  
cad.

**750,00**